

ENCLOSURES & ACCESSORIES



- Power Distribution Enclosures
- Plastic Enclosures
- Steel Enclosures
- Stainless Steel Enclosures
- GRP Enclosures
- Mains Distribution Cabinets
- Universal Electric Meter Boxes
- Compression Glands & Locknuts



CONTENTS

INTRODUCTION

Features across the range 3

MARLANVIL PLASTIC ENCLOSURES

Snap On - Plain/Solid Lid 3

Round - rubber gaskets 3

Square - rubber gaskets 3

Screw On - Plain/Solid Lid Square & Rectangular - blank sides 4

Screw On - Plain/Solid Lid Rectangular - High Top - blank sides 5

Snap Closing Cover - Plastic Adaptable Box 5

Screw On - Open Front Rectangular - complete with DIN Rail 6

Screw On - Transparent Front Rectangular 6

Screw On - Tinted Hinged Front Rectangular
- complete with DIN Rail - for RCD/MCBs 7

Distribution Boards - Screw On - Tinted hinged Front Rectangular
- complete with DIN Rail 7

Screw On - Tinted Hinged Front Door Rectangular
- complete with DIN Rail 8

Plastic Enclosure Accessories 8

STEEL ENCLOSURES

MCG Modular Enclosures - IP20 Single Phase - for indoor applications 9

MCG Modular Enclosure - IP65 Single Phase - for external applications 9

MCG Hinged Door - IP65 Solid Doors 10

MCG Accessories 10

ETA Hinged Door - IP66 Solid & Transparent Doors 11

ETA Accessories 11

MCG STAINLESS STEEL ENCLOSURES

Hinged Door - IP65 Solid Doors 12

Accessories 12

Hinged Door - IP66 Solid Doors 13

Accessories 13

URIARTE GRP ENCLOSURES

Screw-on Lid - Solid 14

Hinged Door - Plain 15

Hinged Door - Glazed 15

Accessories 15

General Accessories 16

CABINETS

Mains Distribution Cabinets - IP54 17

UNIVERSAL ELECTRIC METER BOXES

Suitable for all domestic Electric Meters 18

Suitable for Three Phase Electric Meters 18

Accessories 18

COMPRESSION GLANDS & LOCKNUTS

Standard Thread Glands 19

Long Thread Glands 19

IP68 Blanking Plug 19



DID YOU KNOW?

MCG are now Official Distributors of Lucy Zodion Power Distribution Enclosures.

Scan the QR code to access the Digital Brochure.

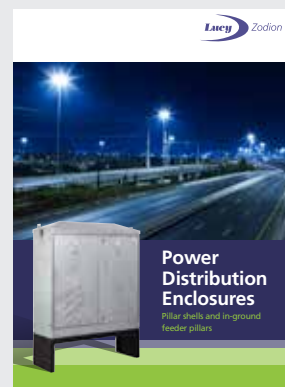

INTRODUCTION

All Enclosures are designed and manufactured in an extensive range of materials and sizes to the highest European standards.



Features across the range include:

- Manufactured from Thermo-resistant technopolymers [UV stabilized]
- Wide choice of sizes and specifications
- Installation temperature: Max=+60° C - Min=-25° C
- Fire resistance: Glow wire test 650° C
- High resistance to chemicals and weather
- Screw on, snap on, solid and transparent covers
- Self-tapping stainless steel screws or nylon screws
- EPDM Rubber Gaskets
- Moulded or fitted DIN Rails, depending on model
- Mounting Plates and accessories available separately
- Standards: EN 60670-1:2005 - EN 60670-22:2006
- Colour RAL 7035 - Grey [Unless stated]
- IP ingress protection depending on the model

PLASTIC ENCLOSURES

Snap On - Plain/Solid Lid ROUND - Rubber Gaskets

Code	Ref No.	Lid Type	Dimensions [mm]		Screw or Fixing Type	General	IP Rating	Colour
			Ø	D				
2095-3081	001	Solid	65	35	Snap Cover	c/w Side Gland Nipples x4	IP44	Grey
2341-7167	001 BLACK	Solid	65	35	Snap Cover	c/w Side Gland Nipples x4	IP44	Black
2095-3084	002	Solid	80	40	Snap Cover	c/w Side Gland Nipples x4	IP44	Grey
2341-7170	002 BLACK	Solid	80	40	Snap Cover	c/w Side Gland Nipples x4	IP44	Black



001



001 BLACK

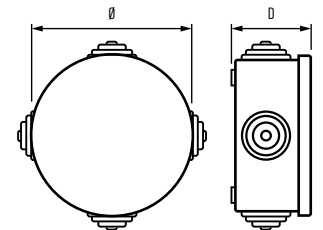

Snap On - Plain/Solid Lid SQUARE - Rubber Gaskets

Code	Ref No.	Lid Type	Dimensions [mm]			Screw or Fixing Type	General	IP Rating	Colour
			H	W	D				
2095-3087	003	Solid	80	80	40	Snap Cover	c/w Side Gland Nipples x6	IP44	Grey
2341-7173	003 BLACK	Solid	80	80	40	Snap Cover	c/w Side Gland Nipples x6	IP44	Black



003



003 BLACK

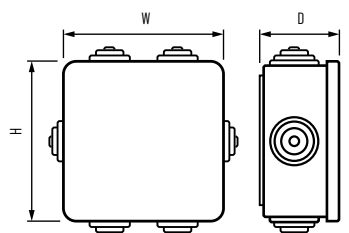

PLASTIC ENCLOSURES

Screw On - Plain/Solid Lid SQUARE & RECTANGULAR - Blank Sides



Code	Ref No.	Lid Type	Dimensions [mm]			Screw or Fixing Type	General	IP Rating	Colour	Mounting Plate to fit
			H	W	D					
1868-7337	005.PL	Solid	100	100	50	Stainless Steel	Blank Sides	IP66	Grey	-
2094-6730	005.PL BLACK	Solid	100	100	50	Stainless Steel	Blank Sides	IP66	Black	-
2355-7498	005.PL WHITE	Solid	100	100	50	Stainless Steel	Blank Sides	IP66	White	-
2095-3093	006.PL	Solid	100	100	70	Stainless Steel	Blank Sides	IP66	Grey	-
2341-7176	006.PL BLACK	Solid	100	100	70	Stainless Steel	Blank Sides	IP66	Black	-
2411-2882	007.PL	Solid	75	123	51	Stainless Steel	Blank Sides	IP66	Grey	-
1866-0130	008.PL	Solid	110	150	70	Stainless Steel	Blank Sides	IP66	Grey	-
2341-7182	008.PL BLACK	Solid	110	150	70	Stainless Steel	Blank Sides	IP66	Black	-
1900-2097	009.PL	Solid	145	190	72	Stainless Steel	Blank Sides	IP66	Grey	1009.PF
2341-7188	009.PL BLACK	Solid	145	190	72	Stainless Steel	Blank Sides	IP66	Black	1009.PF
1868-7352	010.PL	Solid	190	243	90	Stainless Steel	Blank Sides	IP66	Grey	1010.PF
2341-7191	010.PL Black	Solid	190	243	90	Stainless Steel	Blank Sides	IP66	Black	1010.PF
2095-3105	010.PL.70	Solid	190	243	70	Stainless Steel	Blank Sides	IP66	Grey	1010.PF
2341-7194	010.PL.70 Black	Solid	190	243	70	Stainless Steel	Blank Sides	IP66	Black	1010.PF
1868-7343	009.A.PL	Solid	140	190	75	Nylon	Blank Sides	IP66	Grey	1009.PF
1868-7349	010.A.PL	Solid	190	238	90	Nylon	Blank Sides	IP66	Grey	1010.PF
1829-8504	012.A.PL	Solid	220	300	120	Nylon	Blank Sides	IP66	Grey	1012.PF
2341-7197	012.A.PL BLACK	Solid	220	300	120	Nylon	Blank Sides	IP66	Black	1012.PF
1868-7364	014.A.PL	Solid	300	376	120	Nylon	Blank Sides	IP66	Grey	1014.PF
0013-3876	5WTB25*	Solid	100	100	55	Nylon	Blank Sides	IP65	Grey	-

* Complete with 25A 5 Way Terminal Strip

For Mounting Plates see page 8



014.A.PL



010.PL



005.PL BLACK

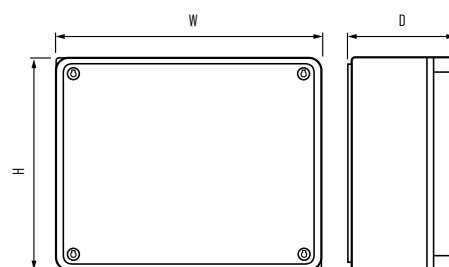

PLASTIC ENCLOSURES

Screw On - Plain/Solid Lid
RECTANGULAR - High Top - Blank Sides



Code	Ref No.	Lid Type	Dimensions [mm]			Screw Type or Fixing Type	General	IP Rating	Colour	Mounting Plate to fit
			H	W	D					
2095-3096	008.CA.G	Solid - High Top	110	150	135	Stainless Steel Screw	Blank Sides	IP66	Grey	-
2341-7179	008.CA BLACK	Solid - High Top	110	150	135	Stainless Steel Screw	Blank Sides	IP66	Black	-
2095-3099	009.CA.G	Solid - High Top	145	190	135	Stainless Steel Screw	Blank Sides	IP66	Grey	1009.PF
2341-7185	009.CA BLACK	Solid - High Top	145	190	135	Stainless Steel Screw	Blank Sides	IP66	Black	1009.PF
2095-3102	010.CA.G	Solid - High Top	190	243	155	Stainless Steel Screw	Blank Sides	IP66	Grey	1010.PF
2095-3108	014.CA.G	Solid - High Top	300	376	180	Nylon Screw	Blank Sides	IP65	Grey	1014.PF
2095-3111	015.CA.G	Solid - High Top	380	460	182	Nylon Screw	Blank Sides	IP65	Grey	1015.PF

For Mounting Plates see page 8

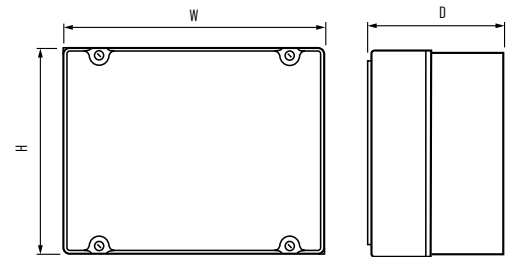

Snap Closing Cover - Plastic Adaptable Box

- Grey snap closing cover
- Side and rear grommet cable entries
- Internal: 94mm x 94mm x 50mm
- Base Height: 50mm
- Lid Height: 8mm



Code	Ref No.	Lid Type	Dimensions [mm]			Screw Type or Fixing Type	General	IP Rating	Colour
			H	W	D				
2095-3090	005.CS	Solid	94	94	50	Snap Closing Cover	94mm x 94mm x 50mm Plastic Adaptable Box	IP65	Grey

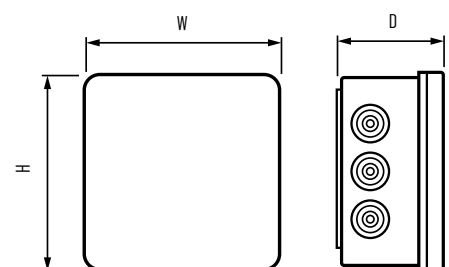

PLASTIC ENCLOSURES

Screw On - Open Front RECTANGULAR - complete with DIN Rail



Code	Ref No.	Lid Type	Dimensions [mm]			Screw Type	DIN Rail	Modules	IP Rating	Colour
			H	W	D					
1868-7403	90.02	Open Front	135	55	80	Stainless Steel	Moulded Plastic - Fitted	1 to 2	IP40	Grey
1868-7406	90.04	Open Front	135	100	90	Stainless Steel	Moulded Plastic - Fitted	2 to 4	IP40	Grey
1868-7409	90.06	Open Front	135	140	90	Stainless Steel	Moulded Plastic - Fitted	4 to 6	IP40	Grey
1868-7412	90.08	Open Front	160	200	90	Stainless Steel	Moulded Plastic - Fitted	4 to 8	IP40	Grey

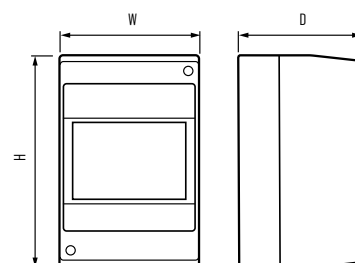

Screw On - Transparent Front RECTANGULAR



Code	Ref No.	Lid Type	Dimensions [mm]			Screw Type	General	IP Rating	Mounting Plate to fit
			H	W	D				
2095-4260	008.PK	Transparent	110	150	70	Stainless Steel	Blank Sides	IP66	-
1868-7340	009.A.PK	Transparent	145	190	75	Nylon	Blank Modular Sides	IP66	1009.PF
1868-7346	010.A.PK	Transparent	190	240	90	Nylon	Blank Modular Sides	IP66	1010.PF
1868-7355	012.A.PK	Transparent	220	300	120	Nylon	Blank Modular Sides	IP66	1012.PF
1868-7361	014.A.PK	Transparent	300	380	120	Nylon	Blank Modular Sides	IP66	1014.PF

For Mounting Plates see page 8

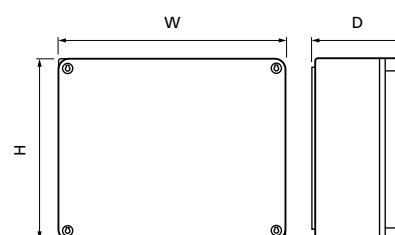

PLASTIC ENCLOSURES

**Screw On - Tinted Hinged Front
RECTANGULAR - complete with DIN Rail - for RCD/MCBs**



Code	Ref No.	Transparent Lid Type	Dimensions [mm]			Screw Type	DIN Rail	Modules	Power Rating	IP Rating	Earth/Neutral Bar c/w support to fit
			H	W	D						
1868-7415	92.04	Front Flap - Tinted	160	120	90	Stainless Steel	Metal - Fitted	3 to 5	8W	IP65	1006.4 [4-Way]
2341-7203	92.04 BLACK	Front Flap - Tinted	160	120	90	Stainless Steel	Metal - Fitted	3 to 5	8W	IP65	1006.4 [4-Way]
1895-8021	92.E.04	Front Flap - Tinted	160	120	90	Stainless Steel	Metal - Fitted	3 to 5	8W	IP65	1006.4 [4-Way]
1868-7418	92.08	Front Flap - Tinted	160	200	90	Stainless Steel	Metal - Fitted	Up to 8	11W	IP65	1006.8 [8-Way]
2341-7206	92.08 BLACK	Front Flap - Tinted	160	200	90	Stainless Steel	Metal - Fitted	Up to 8	11W	IP65	1006.8 [8-Way]
1868-7421	92.12	Front Flap - Tinted	200	250	110	Stainless Steel	Metal - Fitted	Up to 12	17W	IP65	1006.12 [12-Way]

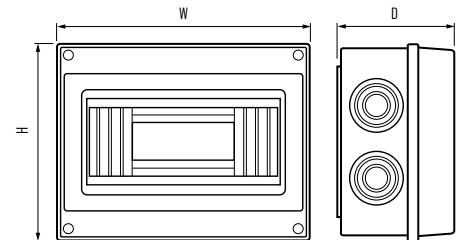

**DISTRIBUTION BOARDS
Screw On - Tinted hinged Front
RECTANGULAR - complete with DIN Rail**



Units can be used individually or assembled to make up special Distribution Boards.

Code	Ref No.	Transparent Door Type	Dimensions [mm]			Screw Type	DIN Rail	Banks	Modules	Power Rating	IP Rating	Earth/Neutral Bar c/w support to fit
			H	W	D							
1868-7424	920.12	Front - Tinted	250	250	140	Nylon	Metal - Fitted	1	Up to 12	20W	IP65	1006.12 [1 x 12-Way]
1868-7427	920.24	Front - Tinted	250	375	140	Nylon	Metal - Fitted	2	Up to 24	30W	IP65	1006.12 [2 x 12-Way]
1868-7430	920.48	Front - Tinted	500	355	140	Nylon	Metal - Fitted	3	Up to 48	45W	IP65	1006.12 [4 x 12-Way]
1868-7436	960.22001*	Front - Tinted	375	250	145	Nylon	Metal - Fitted	1	Up to 12	-	IP65	-

* Suitable for BS4343 16A Sockets [Maximum 3]

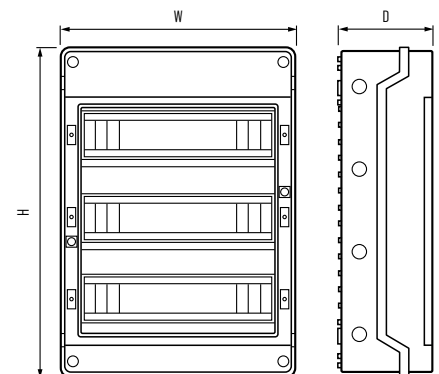

PLASTIC ENCLOSURES

MISCELLANEOUS DISTRIBUTION BOARDS

Screw On - Tinted, Hinged Front Door

RECTANGULAR - complete with DIN Rail



Code	Ref No.	Transparent Door Type	Dimensions [mm]			General	DIN Rail	Modules	Power Rating	IP Rating
			H	W	D					
1868-7433	940.02*	Front - Tinted	156	102	100	Blank Sides	Metal - Fitted	2	10W	IP65
0070-2505	960.21001	Front - Tinted	310	230	110	-	Metal - Fitted	10 [4 Sockets 16 Amp]	-	IP44

* Complies with EU 2002/95/EC RoHS Deca-BDE



940.02



960.21001

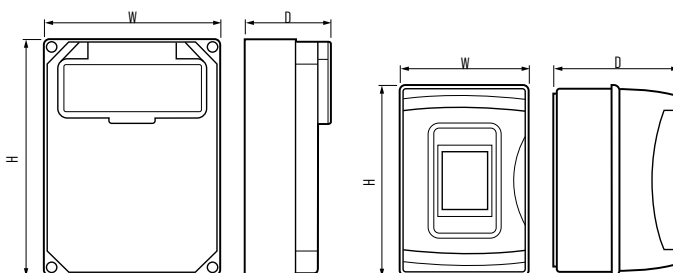

PLASTIC ENCLOSURE ACCESSORIES

A range of essential accessories to complement the whole range of Marlanvil plastic enclosures.



Code	Ref No.	Description	To Fit / Description	Screw Type	Dimensions [mm]		
					H	W	D
1868-7391	1009.PF	Metal Mounting Plate c/w screws	All 009 Range Enclosures	Metal	180	118	1.5
1868-7394	1010.PF	Metal Mounting Plate c/w screws	All 010 Range Enclosures	Metal	212	162	1.5
1868-7397	1012.PF	Metal Mounting Plate c/w screws	All 012 Range Enclosures	Metal	270	190	1.5
1868-7400	1014.PF	Metal Mounting Plate c/w screws	All 014 Range Enclosures	Metal	358	283	1.5
2095-3114	1015.PF	Metal Mounting Plate c/w screws	All 015 Range Enclosures	Metal	424	341	1.5
1868-7370	1000.T	Module Blanks - Grey	For Grey Distribution Enclosures	-	-	-	-
2341-7200	1000.T Black	Module Blanks - Black	For Black Distribution Enclosures	-	-	-	-
1868-7373	1004.1	Earth/Neutral Brass Terminal	5 x 16mm ² Terminals	-	-	-	-
1868-7376	1004.3	Earth/Neutral Brass Terminal	2 x 16mm ² & 8 x 10mm ² Terminals	-	-	-	-
1868-7379	1004.4	Earth/Neutral Brass Terminal	2 x 16mm ² & 12 x 10mm ² Terminals	-	-	-	-
1868-7382	1006.04*	Earth/Neutral Brass Connector Kit	5 x 16mm ² E & N Terminals	-	-	-	-
1868-7385	1006.08*	Earth/Neutral Brass Connector Kit	2 x 16mm ² & 8 x 10mm ² E & N Terminals	-	-	-	-
1868-7388	1006.12*	Earth/Neutral Brass Connector Kit	2 x 16mm ² & 12 x 10mm ² E & N Terminals	-	-	-	-

* Complete with plastic mounting frame

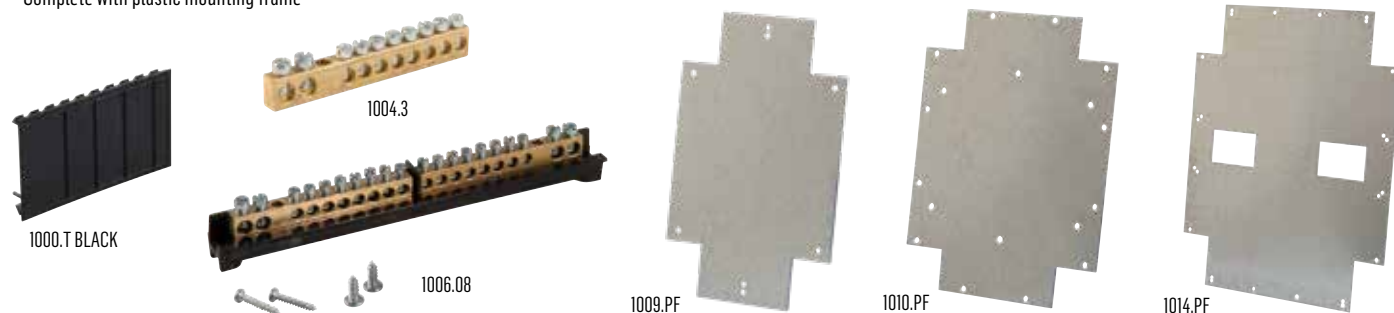

STEEL ENCLOSURES

MODULAR ENCLOSURES - IP20
Single Phase - for Indoor applications



A range of blank metal consumer unit enclosures which fully conform to BS7671 Amendment 3: 2015 and BS EN61439-3 of the 17th Edition Regulations.

- Fully enclosed 1mm thick, metal construction body with drop down metal cover, DIN rail and Earth bar
- Raised key holes for secure easy installation
- Circular cable entry knock-outs [M20 and/or M25], top and bottom
- All are finished in white polyester powder coating to RAL9010

Code	Ref No.	Body Type	Free Ways	Dimensions [mm]			IP Rating
				H	W	D	
1868-7391	ME2S	Small	2	145	80	82	IP20
1868-7394	ME2L	Large	2	225	80	82	IP20
1868-7397	ME3S	Small	3	175	110	82	IP20
1868-7400	ME3L	Large	3	225	115	82	IP20
2095-3114	ME4S	Small	4	175	110	82	IP20
1868-7370	ME4L	Large	4	225	115	82	IP20
2341-7200	ME6L	Large	6	235	161	110	IP20
1868-7373	ME8L	Large	8	235	197	110	IP20
1868-7376	ME12L	Large	12	235	269	110	IP20



MODULAR ENCLOSURE - IP65
Single Phase - for External applications



IP65 Metal Consumer Enclosure which fully conforms to BS7671 Amendment 3: 2015 and BS EN61439-3 of the current Regulations.

- Fully enclosed 1mm thick, metal construction body with drop down metal cover with retaining clip
- Split load neutral connections - prevents hot spots
- Raised key holes for secure easy installation
- Multiple circular cable entry drill-outs [M20], 2x top, bottom and sides plus 1x at the rear, drillable to M32
- Retained Screws
- Set of 4 Rubber Glands for the drill-outs and 4 Mounting Screw Cap Covers
- Finished in white polyester powder coating to RAL9010 UV stable
- Accessories pack plus a full set of self adhesive graphic or textural, warning and fixing date labels.

Code	Ref No.	Free Ways	Dimensions [mm]			IP Rating
			H	W	D	
2275-1353	MGUE4WIP65	4	220	140	102	IP65



STEEL ENCLOSURES

HINGED DOOR - IP65

Solid Doors

- Galvanised Sheet Steel
- Supplied with Zinc Plated Metal Mounting Plate [2mm]
- Mounting Kit & Key included
- Epoxy powder coated RAL 7035
- Recessed Gland Plate, top or bottom
- Reversible Door hanging
- Polyurethane Gasket
- Standard T-bar Lock
- KEMA Certification
- Compliance to IEC 60529

Code	Ref No.	No. of Locks	Dimensions [mm]			IP Rating
			W	H	D	
1434-9439	M32150	1	200	300	150	IP65
1434-9442	M33150	1	300	300	150	IP65
1434-9445	M33200	1	300	300	200	IP65
1434-9448	M34200	1	400	300	200	IP65
1434-9451	M43150	1	300	400	150	IP65
1434-9454	M43200	1	300	400	200	IP65
1434-9457	M44200	1	400	400	200	IP65
1434-9460	M54200	2	400	500	200	IP65
1434-9463	M55200	2	500	500	200	IP65
1367-5453	M64200	2	400	600	200	IP65
1434-9466	M65200	2	500	600	200	IP65
1434-9469	M66200	2	600	600	200	IP65
1434-9472	M86200	2	600	800	200	IP65
1434-9436	M108300	2	800	1000	300	IP65



M43200



M55200

Accessories

Code	Ref No.	Description
1367-5456	MLOCK	Replacement T-Bar Lock
1577-3434	YALELOCK	Optional Yale type Lock c/w key



MOUNTING KIT PLUS KEY [INCLUDED]

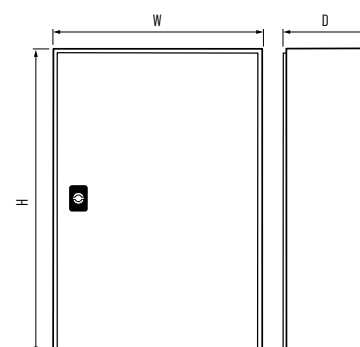

STAINLESS STEEL ENCLOSURES

HINGED DOOR - IP65

Solid Doors

- AISI 304L Grade Stainless Steel
- 2mm Zinc Plated Mounting Plate included [not fitted, supplied loose]
- Door key included
- Reversible Door
- Polyurethane Gasket
- Stainless Steel Lock
- KEMA Certification
- Compliance to IEC 60529



S32150

Code	Ref No.	Dimensions [mm]			IP Rating
		W	H	D	
1367-5459	S32150	200	300	150	IP65
1434-9475	S33150	300	300	150	IP65
1434-9478	S43200	300	400	200	IP65
1434-9481	S44200	400	400	200	IP65



Key [included]

Accessories

Code	Ref No.	Description
1931-0323	SSBRKTSET	29 piece Stainless Steel Bracket Set
1434-9484	SLOCK	Universal Enclosure Key - Metal



SSBRKTSET

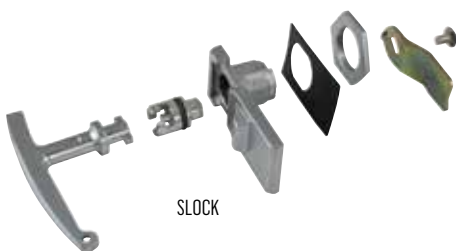

SLOCK



S44200

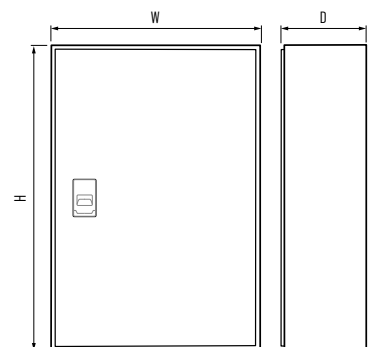

GRP ENCLOSURES

- Glass reinforced polyester [GRP]
- Complies to IEC 62208
- Polyurethane Gasket
- Plastic Screws for lid
- Fixing Kit included
- Plain sides - select your own entry and exit points
- Deep base with a Shallow Clear Lid
- Full range of GRP Mounting Plates [Order Separately]
- Colour RAL7032

URIARTE SAFYBOX www.safybox.com

Screw-on Lid - SOLID

Code	Ref No.	Dimensions [mm]			IP Rating	Code	GRP Mounting Plate To Fit [order separately]
		W	H	D			
2481-3646	SL181313	135	180	130	IP66	2481-3769	MP181313
2481-3652	SL181813	180	180	130	IP66	2481-3772	MP181813
2481-3658	SL271313	135	270	130	IP66	2481-3775	MP271313
1448-7289	SL271817	180	270	170	IP66	1448-7244	MP271817
2481-3667	SL272717	270	270	170	IP66	2481-3778	MP272717
2481-3673	SL361817	180	360	170	IP66	2481-3781	MP361817
1448-7292	SL362717	270	360	170	IP66	1453-4983	MP362717/20
1448-7295	SL362720	270	360	205	IP66	1453-4983	MP362717/20
2481-3685	SL363617	360	360	170	IP66	1448-7253	MP363620
1448-7298	SL363620	360	360	205	IP66	1448-7253	MP363620
2481-3694	SL542717	270	540	170	IP66	2481-3784	MP542717/20
2481-3700	SL542720	270	540	205	IP66	2481-3784	MP542717/20
2481-3706	SL543617	360	540	170	IP66	1448-7265	MP543620
1448-7301	SL543620	360	540	205	IP66	1448-7265	MP543620
2481-3715	SL545417	540	540	170	IP66	1448-7268	MP545420
1448-7304	SL545420	540	540	205	IP66	1448-7268	MP545420
2481-3724	SL723620	360	720	205	IP66	2481-3787	MP723620
1448-7307	SL725420	540	720	205	IP66	1448-7277	MP725420



SL545420



SL271817



SL271817



MP545420

GRP ENCLOSURES

- Glass reinforced polyester [GRP]
- Complies to IEC 62208
- Polyurethane Gasket
- Hinged Lockable Lid
- Fixing Kit included
- The units can be mounted as either Right or Left hand opening
- Plain sides - select your own Entry and Exit points
- Full range of Galvanised Steel Mounting Plates [Order Separately]
- Colour RAL7032

URIARTE SAFYBOX 
www.safybox.com

Please Note:

Due to Laser etching, if you need the door to open left to right, you have to turn the enclosures through 180°, so the logo doesn't become upside down.

Hinged Door - PLAIN

Code	Ref No.	Dimensions [mm]			IP Rating	Code	Steel Mounting Plate To Fit [order separately]
		W	H	D			
1453-4953	HL32140	250	300	140	IP66	1453-4980	MP32140
1448-7226	HL43200	300	400	200	IP66	1448-7256	MP43200
1448-7229	HL44200	400	400	200	IP66	1448-7259	MP44200
1448-7232	HL54200	400	500	200	IP66	1448-7262	MP54200
1448-7235	HL64230	400	600	230	IP66	1448-7271	MP64230
1448-7238	HL65230	500	600	230	IP66	1448-7274	MP65230
2481-3631	HL83230	300	800	230	IP66	2481-3790	MP83230
1448-7241	HL86300	600	800	300	IP66	1448-7280	MP86300



Hinged Door - GLAZED

Code	Ref No.	Dimensions [mm]			IP Rating	Code	Steel Mounting Plate To Fit [order separately]
		W	H	D			
2481-3613	HL32140P	250	300	140	IP66	1453-4980	MP32140
2481-3616	HL43200P	300	400	200	IP66	1448-7256	MP43200
2481-3619	HL44200P	400	400	200	IP66	1448-7259	MP44200
2481-3622	HL54200P	400	500	200	IP66	1448-7262	MP54200
2481-3625	HL64230P	400	600	230	IP66	1448-7271	MP64230
2481-3628	HL65230P	500	600	230	IP66	1448-7274	MP65230
2481-3637	HL86300P	600	800	300	IP66	1448-7280	MP86300



Accessories

Code	Ref No.	Description
1450-9723	HLLOCK	Lock & Key for HL Enclosures



GRP ENCLOSURES ACCESSORIES

GENERAL ACCESSORIES

URIARTE SAFYBOX www.safybox.com

Code	Ref No.	Description
1826-821	OFM-14	Set of 4 Wall Brackets & Screws for HL Enclosures
2481-3733	CBC-13-IN	Stainless Steel Padlock Hasp
2481-3760	DV-6	Large Ventilation Valve



CBC-13-IN



DV-6



OFM-14



MAINS DISTRIBUTION CABINETS - IP54

Manufactured from Glass Reinforced Polyester (GRP), these Lockable Floor Standing Cabinets are built to the highest specification.

Ideal for use in the construction, water and electricity industries for air conditioning units, analysers, communication equipment, control panels, electronic equipment, metering equipment, switchgear, telemetry and transformers.

- Standard colour BS 4800/5252: Green 14 C 39
- Cylinder Rim Lock
- Plywood Backboard
- Stainless Steel Hinges
- Solid GRP Base
- Narrow Door Pillars
- Fire Resistant to BS 476 1972 Part 22

Code	Ref No.	Dimensions W x H x D [mm]
0915-9637	CPS12	750 x 1250 x 400
0915-9631	CPD12	1250 x 1250 x 400
0915-9640	CPS17	900 x 1750 x 500
0915-9634	CPD17	2000 x 1750 x 500



CPD12



CPD12



CPS12

CPD12

CPS17

CPD17

UNIVERSAL ELECTRIC METER BOXES

Suitable for all domestic Electric Meters

Cable entry is at the bottom left hand side, either with surface entry through the architrave which projects 60mm, or via the building cavity. Access Key included.

- Material: Glass reinforced plastic to BS 8567
- Fire Retardant: To ESI Standard 12-3 for external use
- Hinged latched door as standard, hinges on the left hand side
- Pre-fitted baseboard
- Weather resistant - will not corrode or rot
- Pre-drilled cable entry positions c/w grommets [Surface mounted version only]
- Cable entry on the face of the wall or via the cavity



METER/F



METER/S

Code	Ref No.	Description	Colour
0859-7080	METER/F	Recessed Electricity Meter Box c/w Key Dimensions: 430 x 600 x 220mm [W x H x D] Brickwork Opening: 360 x 520 x 150mm [W x H x D]	White
0860-5600	METER/S	Surface Mounted Electricity Meter Box c/w Key Dimensions: 400 x 560 x 215mm [W x H x D]	White

Suitable for Three Phase Electric Meters

- Recessed Electricity Meter Box specifically designed to house a three phase meter.
- Manufactured to ESI Standard 12-3 for external use only.
- Cable entry through the wall cavity or surface entry through the specially designed architrave.
- Complies with BS8567:2012



METER/3PHASE

Code	Ref No.	Description	Colour
2682-3046	METER/3PHASE	Recessed Electricity Meter Box c/w Key Dimensions: 550 x 770 x 210mm [W x H x D]	White
2684-6746	METER/3PHASE S	Surface Electricity Meter Box c/w Key Dimensions: 520 x 750 x 210mm [W x H x D]	White

Accessories

Code	Ref No.	Description
0859-7083	METER/HS	38mm Diameter, 1400mm long Hockey Stick Cable Protector - White - Material uPVC
0886-1269	METER/K	Electric Meter Box Key [1 key]
0886-1272	METER/LK	Latch Kit for Electric Meter Box - Plastic
0886-1275	METER/PH	Set of Pin Hinges for Electric Meter Box
0886-1278	METER/RK	Repair Kit for Electric Meter Box: 2x keys [METER/K] Set of Pin Hinges, [METER/PH] Latch Kit [METER/LK]
0886-1281	METER/SD	Spare Door for Electric Meter Box Dimensions: 383mm x 550mm [W x H]

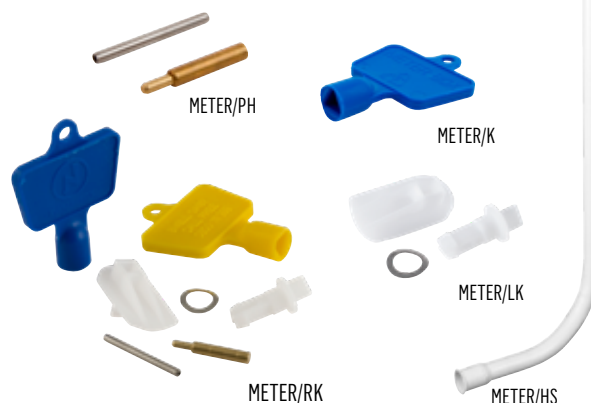

METER/PH

METER/K

METER/LK

METER/RK

METER/HS

COMPRESSION GLANDS & LOCKNUTS

Standard Thread Glands



- Material: Plastic c/w Nylon Washer - Low Smoke & Fume
- Hermetic seal: Nitrile Rubber
- Ambient temperature quiescent state -40°C to 100°C, short time to 120°C
- Dynamic -20°C to 80°C, short time to 100°C
- Available in Grey, Black, White and Red
- IP68 rated [5 Bar]



Metric c/w Lock Nut

Code	Ref No.	Thread	Gland Colour	Clamping Range [mm]	Pack Qty
0013-6675	M12G	M12 x 1.5	Grey	2.5 - 6.5	10
0013-6681	M16G	M16 x 1.5	Grey	4 - 8	10
0013-6687	M20G	M20 x 1.5	Grey	6 - 12	10
0013-6699	M25G	M25 x 1.5	Grey	13 - 18	10
0013-6705	M32G	M32 x 1.5	Grey	16 - 21	10
0070-2589	M40G	M40 x 1.5	Grey	22 - 32	10
0260-9725	M50G	M50 x 1.5	Grey	32 - 38	10
0260-9731	M63G	M63 x 1.5	Grey	37 - 44	10
0070-2517	M16GB	M16 x 1.5	Black	4 - 8	10
0070-2535	M20GB	M20 x 1.5	Black	6 - 12	10
0070-2553	M25GB	M25 x 1.5	Black	13 - 18	10
0070-2571	M32GB	M32 x 1.5	Black	16 - 21	10
0070-2523	M16GW	M16 x 1.5	White	4 - 8	10
0070-2541	M20GW	M20 x 1.5	White	6 - 12	10
0070-2559	M25GW	M25 x 1.5	White	13 - 18	10
0070-2577	M32GW	M32 x 1.5	White	16 - 21	10
0070-2538	M20GR	M20 x 1.5	Red	6 - 12	10
0070-2556	M25GR	M25 x 1.5	Red	13 - 18	10
0070-2574	M32GR	M32 x 1.5	Red	16 - 21	10

Long Thread Glands



- Thread 15mm long
- Material: Plastic c/w Nylon Washer - Low Smoke & Fume
- Hermetic seal: Nitrile Rubber
- Complies with EN 60947-1:2004
- Ambient temperature quiescent state -40°C to 100°C, short time to 120°C
- Dynamic -20°C to 80°C, short time to 100°C
- Available in Grey, Black and White
- Designed for use with round cable only
- IP68 rated [5 Bar]



Metric c/w Lock Nut

Code	Ref No.	Thread	Gland Colour	Clamping Range [mm]	Pack Qty
2293-1050	M20GSL	M20 x 1.5	Grey	6 - 12	10
2293-1059	M20GWL	M20 x 1.5	Grey	10 - 14	10
2293-1068	M32GWL	M32 x 1.5	Grey	18 - 25	10
2293-1053	M20GSLB	M20 x 1.5	Black	6 - 12	10
2293-1062	M20GWLB	M20 x 1.5	Black	10 - 14	10
2293-1071	M32GWLB	M32 x 1.5	Black	18 - 25	10
2293-1056	M20GSLW	M20 x 1.5	White	6 - 12	10
2293-1065	M20GWLW	M20 x 1.5	White	10 - 14	10

IP68 Blanking Plug

- Nylon plastic construction
- Ambient temperature -40°C to 80°C



Code	Ref No.	External Thread	Gland Colour	Pack Quantity
0075-0421	M12BP	M12	Grey	10
0075-0424	M16BP	M16	Grey	10
0075-0427	M20BP	M20	Grey	10
0075-0430	M25BP	M25	Grey	10
0075-0433	M32BP	M32	Grey	10
0075-0436	M40BP	M40	Grey	10
0075-0439	M50BP	M50	Grey	10
0075-0442	M63BP	M63	Grey	10
2562-6028	M16BP BLACK	M16	Black	10
2562-6031	M20BP BLACK	M20	Black	10
2562-6034	M25BP BLACK	M25	Black	10

NOTES

A series of horizontal dotted lines for taking notes, spanning the width of the page below the 'NOTES' header.

MCG[®]
INDUSTRIAL

Unit 1, Railway Court, Ten Pound Walk, Doncaster, South Yorkshire, DN4 5FB
Tel: +44 [0]1302 342 642

mcg.co.uk |  mcg_industrial

MCGCAT04



© MCG 2024 - E&OE Errors and Omissions excepted

MCG1085/04.24